

NavalLine[®] Cables for naval shipbuilding

*Applications
as multifaceted
as the ocean.*

Marine

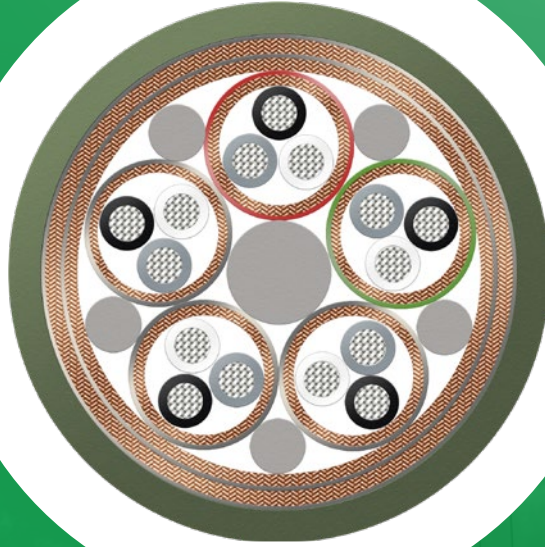



Market portrait Marine

Our solutions for marine applications

With the market Marine, BizLink provides the customers with all the expertise of a global enterprise, focused on the needs of the shipbuilding industry. With an extensive portfolio of products and services, BizLink will assist you across the entire lifecycle of your projects – worldwide.

As a strong partner, BizLink offers application-specific cables and cable system solutions meeting national and international standards. You can trust in the well-founded sector and product knowledge as well as many years of experience.

Innovative quality products, prove and project-related system solutions, as well as highest availability and sustainable service management are matter of course for BizLink.

	Page	
Market portrait Marine	2	
NavalLine® cables for underwater solutions	4	
NavalLine® cables for shipboard application and land-based solutions	6	
Special cable	7	
Special cable, longitudinally water blocked		
acc. to VG 95218 part 29D	7	
acc. to VG 95218 part 29J	8	
acc. to VG 95218 part 29M	9	
acc. to VG 95218 part 29N	9	
Special cable, partially longitudinally water blocked		
acc. to VG 95218 part 29B and C	10	
acc. to VG 95218 part 29E	11	
acc. to VG 95218 part 29F	11	
acc. to VG 95218 part 29G and H	12	
acc. to VG 95218 part 29K	13	
acc. to VG 95218 part 29L	13	
Special cable, water blocked		
acc. to further requirements	14	
Comparison list for BizLink's water blocked cables	15	
Data cable	16	
Data cable Cat. 7	acc. to VG 95218 part 31D	16
Data cable PROFIBUS DP	acc. to VG 95218 part 31X	16
Data cable PROFIBUS DP	acc. to VG 95218 part 31F	17
Data cable CAN-Bus	acc. to VG 95218 part 31H	17
Thermo-compensating cable	acc. to VG 95218-7 type D	18
Installation cable	19	
Installation wire, hook-up	acc. to VG 95218 part 20P	19
Open twisted installation wire	acc. to VG 95218-21 part 21F	21
Lightweight power cables	acc. to VG 95218 part 28C	22
Communication cables	acc. to VG 95218 part 28C	23
Lightweight power cables	acc. to VG 95218 part 28E	24
Lightweight comm. cables	acc. VG 95218 part 28C	24
Lightweight comm. cables	acc. to VG 95218 part 28C	25
Lightweight comm. cables	acc. to VG 95218 part 28E	25
Cross reference list for NavalLine®	acc. to VG 95218 part 28 and 61-66	26
Coaxial cable	acc. to VG 95218 part 101	27
Customized cable	28	
Individually designed NavalLine® installation cable		
acc. to VG 95218-8 / acc. to VG 95218-9	28	
without any relation to VG standards	29	
About BizLink Group	30	
Sales network Marine – worldwide	31	



NavalLine® cables for underwater solutions

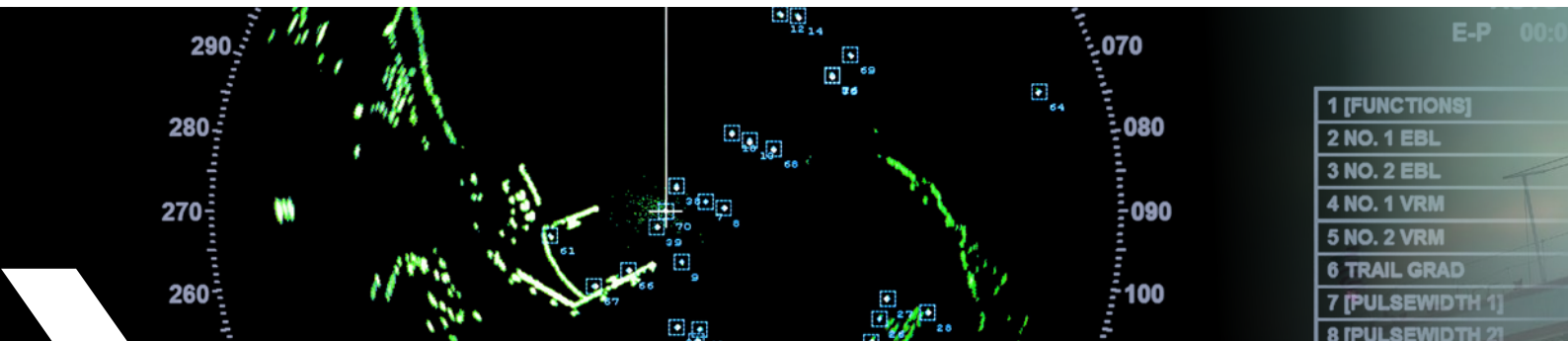

The new cable generation can also be installed onboard of submarines as they conform to the inside installation regulations.

The outboard cables are available with the previous and the new design.

The minimum order quantity is 100 m.

Solutions for marine / shipbuilding

With our NavalLine® products we have specialised in the demands of naval shipbuilding. For instance, along with inboard cables for all naval vessels, we supply laterally and longitudinally waterproof cables for outboard applications on submarines.

Neutral buoyancy and floating trailing and underwater cables or tensile cables with either steel or aramide strain relief elements for rated loads up to several tons as well as coiled cables round off our range for naval shipbuilding. With our NavalLine® products we have specialised in the demands of naval shipbuilding.

We have also available a wide range of cables for land based applications like military vehicles or military safety systems including building installations.

NavalLine®

- longitudinally and transversally water blocked cables
- inboard and outboard applicable
- compliant with VG standards everything is done in our own production plants.

As a manufacturer of customised outboard installation cables for naval vessels, BizLink offers, for more than ten years now, a wide range of cables with the following characteristics:

- seawater resistance
- operating lifetime of 20.000 hours
- transversal and/or longitudinal water blocking up to a pressure of 63 bars

The cables are for example installed in submarines operating in

- Germany
- South Africa
- Turkey
- Israel
- Greece
- Korea



longitudinally
water blocked

transversally
water blocked

HALOGEN
FREE

halogen-free



fire resistant



UV resistant

Solutions acc. to VG 95219 part 29

With the edition of the new German military standard VG 95218 part 29 the cables must also >

- be fire resistant
- have a toxicity index lower than 5*
- be non-corrosive in case of fire*
- have a low smoke density in case of fire*
- be highly oil-resistant*

* not valid for cables VG 95218T029 G-M

VG 95218 part 29 defines two different types of outboard cables

• LWDC

These cables are transversally water blocked up to a pressure of 100 bars and longitudinally completely water blocked up to a pressure of 63 bars.



• PLWDC

These cables are transversally water blocked up to a pressure of 100 bars and longitudinally partially water blocked (all wires are not water blocked) up to a pressure of 63 bars.

In addition to designing cables, which conform to the requirements of the standard VG 95218 part 29 BizLink offers cables which are only transversally water blocked or have to meet other pressure requirements.

As a matter of course we customise cable designs with various types of wires, conductor number and design, colours and strength members to meet your requirements.

Explanation of cable type description for water blocked cables

		
P	Partiell	partial
LWD	LängsWasserDicht	longitudinal water blocked
C	Gesamtschirm	overall screen
CC	Paarschirm und Gesamtschirm, elektrisch nicht getrennt	pairscreen and overall screen, electrically not separated
C-C	Paarschirm und Gesamtschirm, elektrisch getrennt	pairscreen and overall screen, electrically separated

NavaLine® cables for shipboard application and land-based solutions

acc. to VG 95218 part 28 type C and E

Our cable solutions

- › be fire resistant
- › have a toxicity index lower than 5
- › be non-corrosive in case of fire
- › have a low smoke density in case of fire
- › be highly oil-resistant

The types C and E of the standard VG 95218 part 28 defined different types of cables:

LMGSGO ›	Lightweight power cables		with overall screen
FMGSGO ›	Telecommunication cables	with twisted pairs	and overall screen
FMSGSGO ›	Telecommunication cables	with screened twisted pairs	and overall screen
LFMGSSGO ›	Lightweight telecommunication cables	with twisted pairs	and overall double screen
LFMGSGO ›	Lightweight telecommunication cables	with twisted pairs	and overall screen
LFMSGSGO ›	Lightweight telecommunication cables	with twisted pairs	and overall screen
LFMSGSSGO ›	Lightweight telecommunication cables	with screened twisted triples	and overall double screen

Explanation of cable type description for water blocked cables

		
M	Marine	Marine
S	Schirm	Screen
L	Leichte Bauweise	Light construction / design
F	Fernmeldekabel	Telecommunication cable
G	Isolierhülle / Mantel	Insulation / Sheath
O	Ohne Isolationserhalt im Brandfall	Without continuance f insulation effect under fire condition

As a matter of course we customise cable designs with various types of wires, conductor number and design, colours and strength members to meet your requirements.

Special cable longitudinally water blocked

acc. to VG 95218 part 29D

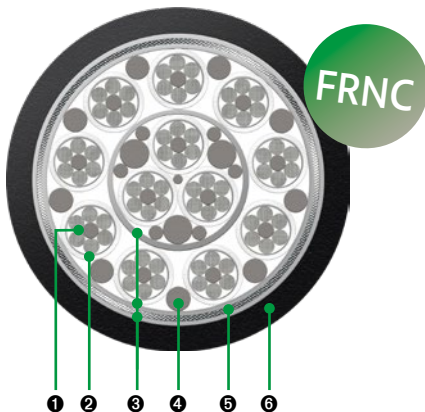

Application & characteristics

Suitable for outside and inside installation on submarines. Operating temperature > -40 °C up to +90 °C

Construction

- ❶ Core > conductor with fine stranded wires, **water-blocking central element**, fine stranded tin-plated copper, **water blocking tape**
- ❷ Insulation > special elastomer, white with black printed numbers
- ❸ **Water-blocking tapes**
- ❹ **Water-blocking fillers**
- ❺ Outer shielding > copper braid with tin-plated wires
- ❻ Sheath > cross-linked, flame retardant, black

Type description	Ø single core max.	Sheath wall thickness min.	Cable Ø min.	Cable Ø max.	Weight max.	Transfer impedance max.	Operating voltage AC/DC	VG part no.	Order no.
	mm	mm	mm	mm	kg/km	mΩ/m	V		
acc. to VG 95218 part 29D									
LWDC 2 x 1.5	3.4	2.0	12.6	13.2	200	30	500	VG95218T029D001	ERK 14036
LWDC 3 x 1.5	3.4	1.8	13.4	13.8	250	30	500	VG95218T029D002	ERK 12313
LWDC 3 G 1.5*	3.4	1.8	13.4	13.8	250	30	500	VG95218T029D003	ERK 14042
LWDC 7 x 1.5	3.4	1.5	15.7	16.2	430	30	500	VG95218T029D004	ERK 14044
LWDC 4 x 2 x 0.75	2.5	2.0	20.6	21.2	560	30	500	VG95218T029D005	ERK 12907
LWDC 12 x 0.75	2.5	2.0	18.5	19.1	540	30	500	VG95218T029D006	ERK 14051
LWDC 12 x 1.5	3.4	2.0	20.9	21.5	700	30	500	VG95218T029D007	ERK 14046
LWDC 24 x 1.5	3.4	2.0	28.1	28.7	1230	30	500	VG95218T029D008	ERK 14049
LWDC 3 x 2 x 0.75	2.5	2.4	17.2	17.8	370	30	500	VG95218T029D009	ERK 023271
LWDC 3 x 0.75	2.5	2.1	10.7	11.3	170	30	500	VG95218T029D010	ERK 023270
LWDC 7 x 2 x 0.75	2.5	2.5	20.7	21.3	600	30	500	VG95218T029D011	ERK 023272
LWDC 9 x 2 x 0.75	2.5	2.8	24.7	25.3	790	30	500	VG95218T029D012	ERK 023273
LWDC 19 x 2 x 0.75	2.5	3.1	32.2	32.8	1300	30	500	VG95218T029D013	ERK 023636
LWDC 4 x 1.5	3.4	2.2	13.7	14.4	270	30	500	VG95218T029D014	ERK 023275
LWDC 4 x 4	4.7	2.2	16.7	17.3	450	30	500	VG95218T029D015	ERK 023276
LWDC 4 x 0.5	2.2	1.5	9.7	10.3	150	30	500	VG95218T029D016	ERK 015084

* G: one green/yellow core

Special cable longitudinally water blocked

acc. to VG 95218 part 29J

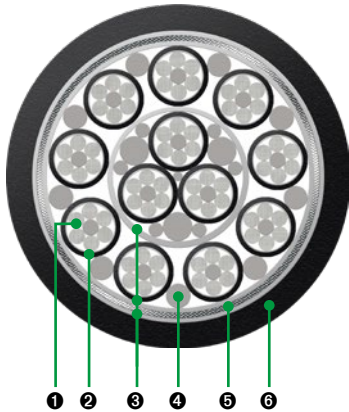

Application & characteristics

Suitable for outside installation on submarines. Suitable for fixed installation and installation in flexible chains.
Operating temperature > -50 °C up to +90 °C

Construction

- ① Core > conductor with fine stranded wires, **water-blocking central element**, fine stranded tin-plated copper, **water blocking tape**
- ② Insulation > special elastomer, black with white printed numbers
- ③ **Water-blocking tapes**
- ④ **Water-blocking fillers**
- ⑤ Outer shielding > copper braid with tin-plated wires
- ⑥ Sheath > polyurethane, flame retardant, black

Type description	Ø single core max.	Sheath wall thickness min.	Cable Ø min.	Cable Ø max.	Weight max.	Transfer impedance max.	Operating voltage AC/DC	VG part no.	Order no.
	mm	mm	mm	mm	kg/km	mΩ/m	V		
acc. to VG 95218 part 29J									
LWDC 2 x 1.5	3.4	2.0	12.6	13.2	200	30	500	VG95218T029J001	ERK 8136
LWDC 3 x 1.5	3.4	1.8	13.4	13.8	250	30	500	VG95218T029J002	ERK 022708
LWDC 3 G 1.5*	3.4	1.8	13.4	13.8	250	30	500	VG95218T029J003	ERK 8172
LWDC 7 x 1.5	3.4	2.0	17.0	17.6	430	30	500	VG95218T029J004	ERK 021538
LWDC 4 x 2 x 0.75	2.5	2.0	18.7	19.3	390	30	500	VG95218T029J005	ERK 8219
LWDC 12 x 0.75	2.5	2.0	18.5	19.1	540	30	500	VG95218T029J006	ERK 8256
LWDC 12 x 1.5	3.4	2.0	21.2	21.8	700	30	500	VG95218T029J007	ERK 6078
LWDC 24 x 1.5	3.4	2.0	28.7	29.3	1,230	30	500	VG95218T029J008	ERK 6339

Special cable longitudinally water blocked

acc. to VG 95218 part 29M

acc. to VG 95218 part 29N

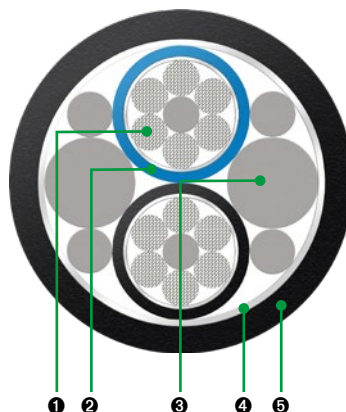
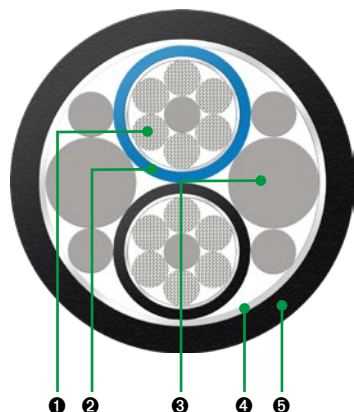

Application & characteristics

Suitable for outside installation on submarines.
 Suitable for fixed installation and installation in flexible chains.
 Operating temperature > -50 °C up to +90 °C

Construction

- ① Core > conductor with fine stranded wires, **water-blocking central element**, fine stranded tin-plated copper, **water blocking tape**
- ② Insulation > special elastomer, black/blue
- ③ **Water-blocking fillers**
- ④ **Water-blocking tape**
- ⑤ Sheath > polyurethane, flame retardant, black

Application & characteristics

Suitable for outside installation on submarines.
 Suitable for fixed installation and installation in flexible chains.
 Operating temperature > -50 °C up to +90 °C

Construction

- ① Core > conductor with fine stranded wires, **water-blocking central element**, fine stranded tin-plated copper, **water blocking tape**
- ② Insulation > special elastomer, black/blue
- ③ **Water-blocking fillers**
- ④ **Water-blocking tape**
- ⑤ Sheath > cross-linked, flame retardant, black

Type description	Ø single core max.	Sheath wall thickness min.	Cable Ø min.	Cable Ø max.	Weight max.	Transfer impedance max.	Operating voltage AC/DC	VG part no.	Order no.
	mm	mm	mm	mm	kg/km	mΩ/m	V		
acc. to VG 95218 part 29M									
LWD 2 x 1.5	3.4	1.4	9.8	10.2	120	-	500	VG95218T029M001	ERK 023487
acc. to VG 95218 part 29N									
LWD 2 x 1.5	3.4	1.4	9.8	10.2	120	-	500	VG95218T029N001	ERK 020133
LWD 2 x 1.5	3.4	1.7	10.5	11.1	150	-	500	VG95218T029N002	ERK 028712

Special cable partially longitudinally water blocked

acc. to VG 95218 part 29B and C

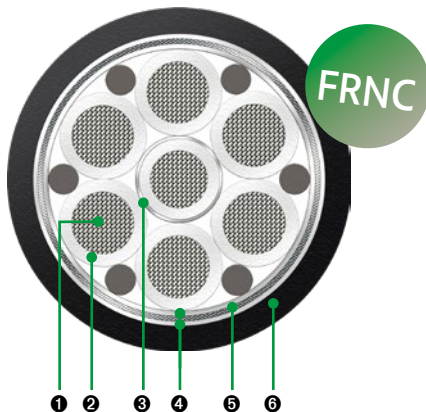

Application & characteristics

Suitable for outside and inside installation on submarines.

Operating temperature > -40 °C up to +90 °C

Construction

- ① Core > conductor with fine stranded tin-plated copper
- ② Insulation > special elastomer, white with black printed numbers
- ③ Water-blocking tapes
- ④ Water-blocking tapes
- ⑤ Outer shielding > copper braid with tin-plated wires
- ⑥ Sheath > cross-linked, flame retardant, black

Type description	Ø single core max.	Sheath wall thickness min.	Cable Ø min.	Cable Ø max.	Weight max.	Transfer impedance max.	Operating voltage AC/DC	VG part no.	Order no.
	mm	mm	mm	mm	kg/km	mΩ/m	V		
acc. to VG 95218 part 29B and C									
PLWDC 1 x 35	11.3	2.0	17.0	17.5	680	30	600	VG95218T029B001	ERK 14090
PLWDC 1 x 120	21.6	2.0	28.7	29.3	2,000	30	600	VG95218T029B002	ERK 14091
PLWDC 1 x 185	25.3	2.0	31.9	32.5	2,900	30	600	VG95218T029B003	ERK 14093
PLWDC 1 x 240	29.8	2.0	35.3	35.9	4,050	30	600	VG95218T029B004	ERK 14097
PLWDC 2 x 1.5	2.4	1.5	9.4	10.0	150	30	500	VG95218T029C001	ERK 14055
PLWDC 3 x 1.5	2.4	1.5	9.7	10.3	160	30	500	VG95218T029C002	ERK 14056
PLWDC 3 G 1.5*	2.4	1.5	9.7	10.3	160	30	500	VG95218T029C003	ERK 14057
PLWDC 4 x 0.5	1.5	1.5	9.5	9.7	140	30	500	VG95218T029C004	ERK 14602
PLWDC 4 x 1.0	2.2	1.8	10.0	10.6	175	30	500	VG95218T029C005	ERK 12261
PLWDC 4 x 6 + 2 x 1.0	5.2/2.2	2.0	18.7	19.3	785	30	500	VG95218T029C006	ERK 14071
PLWDC 7 x 1.5	2.4	1.5	11.6	12.2	250	30	500	VG95218T029C007	ERK 14060
PLWDC 4 x 2 x 0.75	1.9	1.8	14.3	14.9	275	30	500	VG95218T029C008	ERK 12265
PLWDC 12 x 1.5	2.4	1.8	15.1	15.7	425	30	500	VG95218T029C009	ERK 14061
PLWDC 8 x 2 x 0.75	1.9	1.8	16.9	17.5	420	30	500	VG95218T029C010	ERK 14069
PLWDC 24 x 1.5	2.4	2.5	21.5	22.1	835	30	500	VG95218T029C011	ERK 14065
PLWDC 37 x 0.75	1.9	2.0	18.3	18.9	650	30	500	VG95218T029C012	ERK 14066
PLWDC 27 x 2 x 0.38	1.35	2.0	22.0	22.6	630	30	500	VG95218T029C013	ERK 14081
PLWDC 19 x 6	5.2	2.5	32.5	33.0	1,800	30	500	VG95218T029C014	ERK 14324
PLWDC 4 x 0.5	1.5	0.5	6.0	6.2	65	30	500	VG95218T029C015	ERK 14173
PLWDC 2 x 0.75	1.9	1.3	7.8	8.2	96	30	500	VG95218T029C016	ERK 014605
PLWDC 2 x 6.0	5.2	2.0	16.8	17.4	410	30	500	VG95218T029C017	ERK 014648
PLWDC 5 x 1.5	2.4	1.5	11.3	11.8	230	30	500	VG95218T029C018	ERK 014949
PLWDC 5G 1.5*	2.4	1.5	11.3	11.8	230	30	500	VG95218T029C019	ERK 015259
PLWDC 10 x 2 x 0.75	1.9	2.0	21.2	21.8	600	30	500	VG95218T029C020	ERK 014741
PLWDC 3 x 0.75	1.9	1.3	8.0	8.4	110	30	500	VG95218T029C021	ERK 014808

* G: one green/yellow core

Special cable longitudinally water blocked

acc. to VG 95218 part 29E

acc. to VG 95218 part 29F

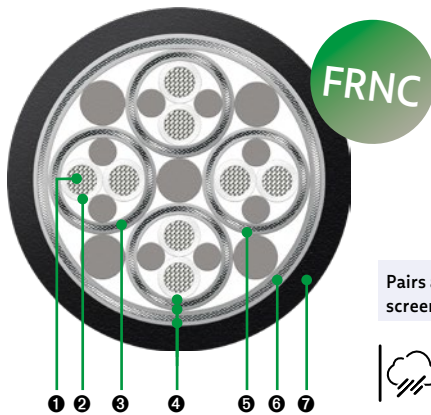
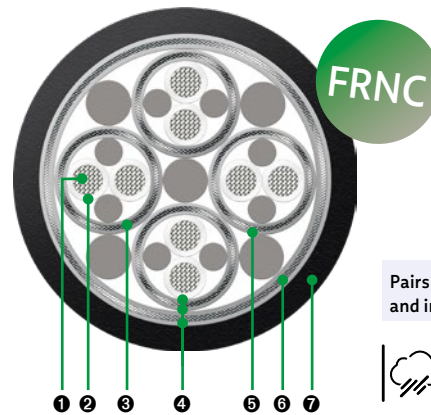
Pairs are screened,
screens are not insulatedPairs are screened
and insulated

Application & characteristics

Suitable for outside and inside installation on submarines.
Operating temperature > -40 °C up to +90 °C

Construction

- ① Core > conductor with fine stranded tin-plated copper
- ② Insulation > special elastomer, white with black printed numbers
- ③ Pair shielding > copper braid with tin-plated wires
- ④ Water-blocking tapes
- ⑤ Water-blocking fillers
- ⑥ Outer shielding > copper braid with tin-plated wires
- ⑦ Sheath > cross-linked, flame retardant, black

Application & characteristics

Suitable for outside and inside installation on submarines.
Operating temperature > -40 °C up to +90 °C

Construction

- ① Core > conductor with fine stranded tin-plated copper
- ② Insulation > special elastomer, white with black printed numbers
- ③ Pair shielding > copper braid with tin-plated wires
- ④ Inner covering > special elastomer
- ⑤ Water-blocking tapes
- ⑥ Water-blocking fillers
- ⑦ Outer shielding > copper braid with tin-plated wires
- ⑧ Sheath > cross-linked, flame retardant, black

Type description	Ø single core max.	Sheath wall thickness min.	Cable Ø min.	Cable Ø max.	Weight max.	Transfer impedance max.	Operating voltage AC/DC	VG part no.	Order no.
	mm	mm	mm	mm	kg/km	mΩ/m	V		
acc. to VG 95218 part 29E									
PLWDCC 4 x 2 x 0.75	1.9	1.7	17.8	18.4	430	15	500	VG95218T029E001	ERK 014647
PLWDCC 8 x 2 x 0.75	1.9	2.0	22.1	22.7	720	15	500	VG95218T029E002	ERK 015249
PLWDCC 10 x 2 x 0.75	1.9	2.0	26.3	26.9	900	15	500	VG95218T029E003	ERK 015252
PLWDCC 27 x 2 x 0.38	1.3	2.5	34.1	34.7	1,500	15	500	VG95218T029E004	ERK 015267
PLWDCC 7 x 2 x 0.75	1.9	2.0	19.8	20.4	650	15	500	VG95218T029E005	ERK 015025

acc. to VG 95218 part 29F									
PLWDC-C 4 x 2 x 0.75	1.9	2.0	20.5	20.9	530	15	500	VG95218T029F001	ERK 019258
PLWDC-C 8 x 2 x 0.75	1.9	2.0	26.1	26.5	880	15	500	VG95218T029F002	ERK 015254
PLWDC-C 10 x 2 x 0.75	1.9	2.0	32.3	32.9	1,350	15	500	VG95218T029F003	ERK 015257
PLWDC-C 27 x 2 x 0.38	1.3	3.0	42.1	42.7	1,800	15	500	VG95218T029F004	ERK 015266
PLWDC-C 12 x 2 x 0.38	1.9	2.0	30.6	31.2	1,190	15	500	VG95218T029F005	ERK 014950
PLWDC-C 2 x 2 x 0.75	1.9	2.0	17.7	18.3	540	15	500	VG95218T029F006	ERK 023637

Special cable partially longitudinally water blocked

acc. to VG 95218 part 29G and H

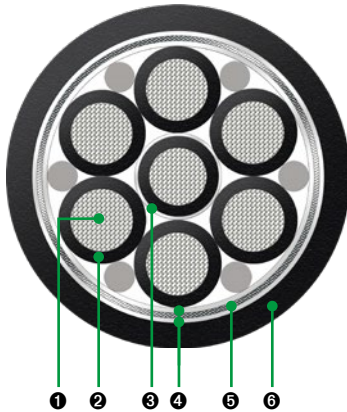

Application & characteristics

Suitable for outside installation on submarines.

Suitable for fixed installation and installation in flexible chains.

Operating temperature > -50 °C up to +90 °C

Construction

- ① Core > conductor with fine stranded tin-plated copper
- ② Insulation > special elastomer, black with white printed numbers
- ③ Water-blocking tapes
- ④ Water-blocking fillers
- ⑤ Outer shielding > copper braid with tin-plated wires
- ⑥ Sheath > polyurethane, flame retardant, black

Type description	Ø single core max.	Sheath wall thickness min.	Cable Ø min.	Cable Ø max.	Weight max.	Transfer impedance max.	Operating voltage AC/DC	VG part no.	Order no.
	mm	mm	mm	mm	kg/km	mΩ/m	V		
acc. to VG 95218 part 29G and H									
PLWDC 1 x 35	11.3	2.0	17.0	17.5	680	30	600/900	VG95218T029G001	ERK 019361
PLWDC 1 x 120	21.6	2.0	28.7	29.3	2,000	30	600/900	VG95218T029G002	ERK 019358
PLWDC 1 x 185	25.3	2.0	31.9	32.5	2,900	30	600/900	VG95218T029G003	ERK 023045
PLWDC 1 x 240	29.8	2.0	35.0	36.5	4,050	30	600/900	VG95218T029G004	ERK 019360
PLWDC 2 x 1.5	2.4	2.2	10.4	11.0	150	30	500	VG95218T029H001	ERK 019367
PLWDC 3 x 1.5	2.4	2.0	10.8	11.2	170	30	500	VG95218T029H002	ERK 019370
PLWDC 3 G 1.5*	2.4	2.0	10.8	11.2	170	30	500	VG95218T029H003	ERK 015666
PLWDC 4 x 0.5	1.5	2.0	9.3	9.7	140	30	500	VG95218T029H004	ERK 019388
PLWDC 4 x 1.0	2.2	1.8	10.0	10.6	175	30	500	VG95218T029H005	ERK 6422
PLWDC 4 x 6 + 2 x 1.0	5.2/2.2	2.0	18.7	19.3	785	30	500	VG95218T029H006	EHRK 6424
PLWDC 7x 1.5	2.4	2.0	13.3	13.7	280	30	500	VG95218T029H007	ERK 019387
PLWDC 4 x 2 x 0.75	1.9	1.8	14.8	15.2	275	30	500	VG95218T029H008	ERK 019371
PLWDC 12 x 1.5	2.4	1.8	16.2	16.6	425	30	500	VG95218T029H009	ERK 019363
PLWDC 8 x 2 x 0.75	1.9	1.8	16.9	17.5	415	30	500	VG95218T029H010	ERK 019374
PLWDC 24 x 1.5	2.4	2.0	20.8	21.4	835	30	500	VG95218T029H011	ERK 019385
PLWDC 37 x 0.75	1.9	1.5	18.3	18.9	650	30	500	VG95218T029H012	ERK 019386
PLWDC 27 x 2 x 0.38	1.35	1.5	22.0	22.6	630	30	500	VG95218T029H013	ERK 6499
PLWDC 19 x 6	5.2	2.5	33.0	33.5	1,800	30	500	VG95218T029H014	ERK 5870
PLWDC 4 x 0.5	1.5	0.5	6.0	6.4	70	30	500	VG95218T029H015	ERK 019372
PLWDC 2 x 0.75	1.9	1.3	7.8	8.2	96	30	500	VG 95218T29H016	ERK 020197
PLWDC 2 x 6.0	5.2	2.0	16.8	17.4	410	30	500	VG 95218T29H017	ERK 014089
PLWDC 5 x 1.5	2.4	1.8	11.6	12.0	230	30	500	VG 95218T29H018	ERK 019373
PLWDC 5G 1.5*	2.4	1.8	11.6	12.0	230	30	500	VG 95218T29H019	ERK 022700
PLWDC 10 x 2 x 0.75	1.9	2.0	21.9	22.5	600	30	500	VG 95218T29H020	ERK 020607
PLWDC 3 x 0.75	1.9	1.3	8.0	8.4	110	30	500	VG 95218T29H021	ERK 022702
PLWDC 4 x 6	5.2	2.0	18.7	19.3	785	30	500	VG95218T029H022	ERK 022704
PLWDC 14 x 2 x 0.75	1.9	2.0	24.3	24.9	820	30	500	VG95218Z029H023	ERK 22706

* G: one green/yellow core

Special cable partially longitudinally water blocked

acc. to VG 95218 part 29K

acc. to VG 95218 part 29L

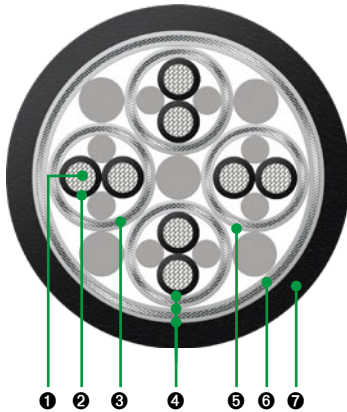
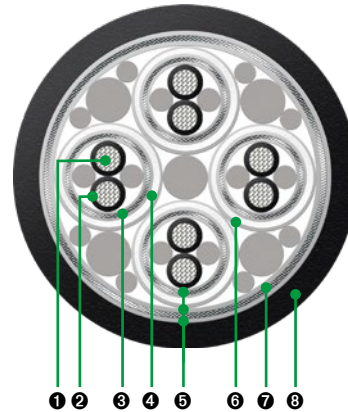
Pairs are screened,
screens are not insulatedPairs are screened
and insulated

Application & characteristics

Suitable for outside installation on submarines.
Suitable for fixed installation and installation in flexible chains.
Operating temperature > $-50\text{ }^{\circ}\text{C}$ up to $+90\text{ }^{\circ}\text{C}$

Construction

- ① Core > conductor with fine stranded tin-plated copper
- ② Insulation > special elastomer, black with white printed numbers
- ③ Pair shielding > copper braid with tin-plated wires
- ④ **Water-blocking tapes**
- ⑤ **Water-blocking fillers**
- ⑥ Outer shielding > copper braid with tin-plated wires
- ⑦ Sheath > polyurethane, flame retardant, black

Application & characteristics

Suitable for outside installation on submarines.
Suitable for fixed installation and installation in flexible chains.
Operating temperature > $-50\text{ }^{\circ}\text{C}$ up to $+90\text{ }^{\circ}\text{C}$

Construction

- ① Core > conductor with fine stranded tin-plated copper
- ② Insulation > special elastomer, black with white printed numbers
- ③ Pair shielding > copper braid with tin-plated wires
- ④ Inner covering > special elastomer
- ⑤ **Water-blocking tapes**
- ⑥ **Water-blocking fillers**
- ⑦ Outer shielding > copper braid with tin-plated wires
- ⑧ Sheath > polyurethane, flame retardant, black

Type description	Ø single core max.	Sheath wall thickness min.	Cable Ø min.	Cable Ø max.	Weight max.	Transfer impedance max.	Operating voltage AC/DC	VG part no.	Order no.
	mm	mm	mm	mm	kg/km	mΩ/m	V		
acc. to VG 95218 part 29K									
PLWDCC 4 x 2 x 0.75	1.9	1.7	17.2	17.8	430	15	500	VG95218T029K001	ERK 7778
PLWDCC 8 x 2 x 0.75	1.9	2.0	22.1	22.7	720	15	500	VG95218T029K002	ERK 6607
PLWDCC 10 x 2 x 0.75	1.9	2.0	26.3	26.9	900	15	500	VG95218T029K003	ERK 6657
PLWDCC 27 x 2 x 0.38	1.3	2.5	34.1	34.7	1,500	15	500	VG95218T029K004	ERK 6770
PLWDCC 7 x 2 x 0.75	1.9	2.0	19.8	20.4	650	15	500	VG95218T029K005	ERK 022197
PLWDCC 14 x 2 x 0.75	1.9	3.0	30.7	31.3	1,200	15	500	VG95218T029K006	ERK 023573

acc. to VG 95218 part 29L									
PLWDC-C 4 x 2 x 0.75	1.9	2.0	20.5	21.1	530	15	500	VG95218T029L001	ERK 019258
PLWDC-C 8 x 2 x 0.75	1.9	2.0	22.7	23.3	680	15	500	VG95218T029L002	ERK 021062
PLWDC-C 10 x 2 x 0.75	1.9	2.0	32.3	32.9	1,350	15	500	VG95218T029L003	ERK 021299
PLWDC-C 27 x 2 x 0.38	1.3	3.0	42.1	42.7	1,800	15	500	VG95218T029L004	ERK 021563
PLWDC-C 12 x 2 x 0.38	1.9	2.0	30.6	31.2	1,190	15	500	VG95218T029L005	ERK 11402
PLWDC-C 2 x 2 x 0.75	1.9	1.8	17.5	18.1	330	15	500	VG95218T029L006	ERK 021580
PLWDC-C 14 x 2 x 0.75	1.9	3.0	36.5	37.5	1,600	15	500	VG95218T029L007	ERK 023533

Special cable water blocked

acc. to further requirements

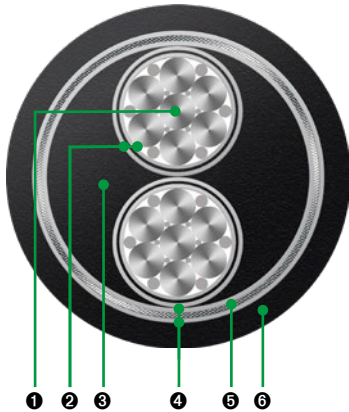

Application & characteristics

Suitable for outside and inside installation on submarines.
 Operating temperature > -40 °C up to +90 °C

Construction

- 1 Core > conductor with fine stranded wires, water-blocking central element, stranded copper
- 2 Insulation > water blocking tape, special elastomer, black with white print 1-2
- 3 Water-blocking filling compound
- 4 Water-blocking tapes
- 5 Outer shielding > copper braid with tin-plated wires
- 6 Sheath > cross-linked, flame retardant, black

Type description	Ø single core max.	Sheath wall thickness min.	Cable Ø min.	Cable Ø max.	Weight max.	Transfer impedance max.	Operating voltage AC/DC	VG part no.	Order no.
	mm	mm	mm	mm	kg/km	mΩ/m	V		
acc. to further requirements									
LWDC 2 x 10 fix	5.9	2.0	20.3	21.5	650	100	500	-	ERK 013218

Comparison list for NavalLine® water blocked cables

Type description	Existing BizLink elocab design numbers (not VG approval)	New BizLink elocab design numbers	VG Order no.	New BizLink elocab design numbers	VG Order no.
	Polyurethane sheath orange	VG approved polyurethane sheath black		VG approved cross-linked sheath halogen free	
PLWDC 1 x 35	ERK 8314	ERK 019361	VG95218T029G001	ERK 14090	VG95218T029B001
PLWDC 1 x 120	ERK 5129	ERK 019358	VG95218T029G002	ERK 14091	VG95218T029B002
PLWDC 1 x 185	ERK 5300	ERK 023045	VG95218T029G003	ERK 14093	VG95218T029B003
PLWDC 1 x 240	ERK 8315	ERK 019360	VG95218T029G004	ERK 14097	VG95218T029B004
PLWDC 2 x 1.5	ERK 5131	ERK 019367	VG95218T029H001	ERK 14055	VG95218T029C001
PLWDC 3 x 1.5	ERK 5000	ERK 019370	VG95218T029H002	ERK 14056	VG95218T029C002
PLWDC 3 G 1.5	-	ERK 015666	VG95218T029H003	ERK 14057	VG95218T029C003
PLWDC 4 x 0.5	ERK 5512	ERK 019388	VG95218T029H004	ERK 14602	VG95218T029C004
PLWDC 4 x 1.0	ERK 6353	ERK 6422	VG95218T029H005	ERK 12261	VG95218T029C005
PLWDC 4 x 6 + 2 x 1	ERK 5149	EHRK 6424	VG95218T029H006	ERK 14071	VG95218T029C006
PLWDC 7 x 1.5	ERK 5044	ERK 019387	VG95218T029H007	ERK 14060	VG95218T029C007
PLWDC 4 x 2 x 0.75	ERK 6054	ERK 019371	VG95218T029H008	ERK 12265	VG95218T029C008
PLWDC 12 x 1.5	ERK 5045	ERK 019363	VG95218T029H009	ERK 14061	VG95218T029C009
PLWDC 8 x 2 x 0.75	ERK 6242	ERK 019374	VG95218T029H010	ERK 14069	VG95218T029C010
PLWDC 24 x 1.5	ERK 5046	ERK 019385	VG95218T029H011	ERK 14065	VG95218T029C011
PLWDC 37 x 0.75	ERK 5004	ERK 019386	VG95218T029H012	ERK 14066	VG95218T029C012
PLWDC 27 x 2 x 0.38	ERK 5299	ERK 6499	VG95218T029H013	ERK 14081	VG95218T029C013
PLWDC 19 x 6.0	ERK 5882	ERK 5870	VG95218T029H014	ERK 14324	VG95218T029C014
PLWDC 4 x 0.5	ERK 5163	ERK 019372	VG95218T029H015	ERK 14173	VG95218T029C015
PLWDC 2 x 0.75	ERK 8978	ERK 020197	VG95218T029H016	ERK 014605	VG95218T029C016
PLWDC 2 x 6.0	ERK13778	ERK 014089	VG95218T029H017	ERK 014648	VG95218T029C017
PLWDC 5 x 1.5	ERK 8313	ERK 019373	VG95218T029H018	ERK 014949	VG95218T029C018
PLWDC 5 G 1.5	ERK 022701	ERK 022700	VG95218T029H019	ERK 015259	VG95218T029C019
PLWDC 10 x 2 x 0.75	ERK 11704	ERK 020607	VG95218T029H020	ERK 014741	VG95218T029C020
PLWDC 3 x 0.75	ERK 022703	ERK 022702	VG95218T029H021	ERK 014808	VG95218T029C021
PLWDC 4 x 6	ERK 022705	ERK 022704	VG95218T029H022	-	-
PLWDC 14 x 2 x 0.75	ERK 022707	ERK 22706	VG95218T029H023	-	-
LWDC 2 x 1.5	ERK 8143	ERK 8136	VG95218T029J001	ERK 14036	VG95218T029D001
LWDC 3 x 1.5	ERK 6093	ERK 022708	VG95218T029J002	ERK 12313	VG95218T029D002
LWDC 3 G 1.5	ERK 8175	ERK 8172	VG95218T029J003	ERK 14042	VG95218T029D003
LWDC 7 x 1.5	ERK 6048	ERK 021538	VG95218T029J004	ERK 14044	VG95218T029D004
LWDC 4 x 2 x 0.75	ERK 8219	ERK 8219	VG95218T029J005	ERK 012907	VG95218T029D005
LWDC 12 x 0.75	ERK 8297	ERK 8256	VG95218T029J006	ERK 014051	VG95218T029D006
LWDC 12 x 1.5	ERK 6214	ERK 6078	VG95218T029J007	ERK 14046	VG95218T029D007
LWDC 24 x 1.5	ERK 6298	ERK 6339	VG95218T029J008	ERK 14049	VG95218T029D008
LWDC 3 x 2 x 0.75	-	-	-	ERK 023271	VG95218T029D009
LWDC 3 x 0.75	-	-	-	ERK 023270	VG95218T029D010
LWDC 7 x 2 x 0.75	-	-	-	ERK 023272	VG95218T029D011
LWDC 9 x 2 x 0.75	-	-	-	ERK 023273	VG95218T029D012
LWDC 19 x 2 x 0.75	-	-	-	ERK 023636	VG95218T029D013
LWDC 4 x 1.5	-	-	-	ERK 023275	VG95218T029D014
LWDC 4 x 4	-	-	-	ERK 023276	VG95218T029D015
LWDC 4 x 0.5	-	-	-	ERK 015084	VG95218T029D016
PLWDCC 4 x 2 x 0.75	ERK 7800	ERK 7778	VG95218T029K001	ERK 014647	VG95218T029E001
PLWDCC 8 x 2 x 0.75	ERK 6610	ERK 6607	VG95218T029K002	ERK 015249	VG95218T029E002
PLWDCC 10 x 2 x 0.75	ERK 6761	ERK 6657	VG95218T029K003	ERK 015252	VG95218T029E003
PLWDCC 27 x 2 x 0.38	ERK 6771	ERK 6770	VG95218T029K004	ERK 015267	VG95218T029E004
PLWDCC 7 x 2 x 0.75	ERK 7799	ERK 022197	VG95218T029K005	ERK 015025	VG95218T029E005
PLWDCC 14 x 2 x 0.75	-	ERK 023573	VG95218T029K006	-	-
PLWDC-C 4 x 2 x 0.75	ERK 019583	ERK 019258	VG95218T029L001	ERK 015253	VG95218T029F001
PLWDC-C 8 x 2 x 0.75	ERK 021064	ERK 021062	VG95218T029L002	ERK 015254	VG95218T029F002
PLWDC-C 10 x 2 x 0.75	ERK 021545	ERK 021299	VG95218T029L003	ERK 015257	VG95218T029F003
PLWDC-C 27 x 2 x 0.38	ERK 021564	ERK 021563	VG95218T029L004	ERK 015266	VG95218T029F004
PLWDC-C 12 x 2 x 0.38	ERK 011401	ERK 11402	VG95218T029L005	ERK 014950	VG95218T029F005
PLWDC-C 2 x 2 x 0.75	ERK 021739	ERK 021580	VG95218T029L006	ERK 023637	VG95218T029F006
PLWDC-C 14 x 2 x 0.75	-	ERK 023533	VG95218T029L007	-	-
LWD 2 x 1.5	ERK 023488	ERK 023487	VG95218T029M001	-	-
LWD 2 x 1.5	-	-	-	ERK 020133	VG95218T029N001
LWD 2 x 1.5	-	-	-	ERK 028712	VG95218T029N002

Data cable Cat. 7

acc. to VG 95218 part 31D

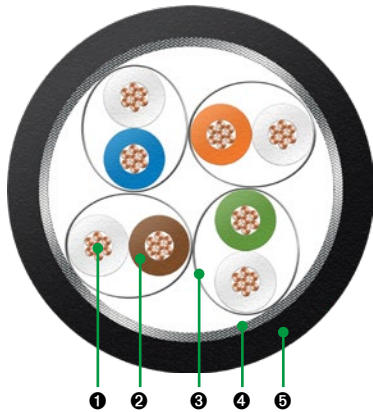

Data cable PROFIBUS DP

acc. to VG 95218 part 31X

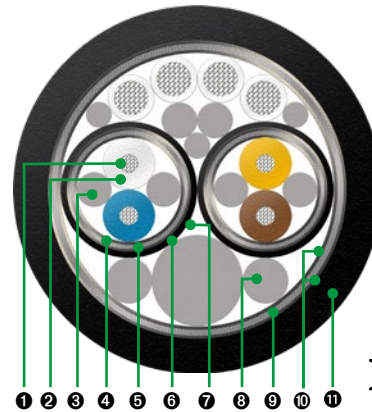

Application & characteristics

Suitable for fixed installation inside military vessels.
 Suitable for fixed installation in harsh environment areas.
 Operating temperature > -33 °C up to +85 °C

Construction

- ① Core > conductor with fine stranded wires,
- ② Insulation > special elastomer, WH/BU, WH/BN, WH/GN, WH/OR
- ③ Pair shielding > aluminated foil
- ④ Outer shielding > copper braid with tin-plated wires
- ⑤ Sheath > flame retardant, cross-linked, black

Application & characteristics

Suitable for control connection between mobile power units.
 Operating temperature > -33 °C up to +85 °C

Construction

- ① Core > conductor with fine stranded wires,
- ② Insulation > special elastomer,
- ③ Filler
- ④ Screening foil
- ⑤ Shielding > copper braid with tin-plated wires
- ⑥ Inner covering
- ⑦ Binder
- ⑧ Filler
- ⑨ Screening braid
- ⑩ Binder
- ⑪ Sheath > flame retardant, cross-linked, black

Type description	Ø single core max.	Sheath wall thickness min.	Cable Ø min.	Cable Ø max.	Weight max.	Transfer impedance max.	Operating voltage AC/DC	VG part no.	Order no.
	mm	mm	mm	mm	kg/km	mΩ/m	V		
acc. to VG 95218 part 31D									
Cat 7 4 x 2 x 0.27	0.7	0.8	8.3	8.8	120	15	125	VG 95218 T031D001	ERK 020654
Cat 7 4 x 2 x 0.355	0.8	1.3	10.6	11.0	150	30	125	VG 95218 T031D002	ERK 017466

acc. to VG 95218 part 31X									
Hybrid cable	2.25	1.5	15.4	16.2	396	30	125 *	VG 95218T031X001	ERK 025309
	2.15						600/900 **		

*data pairs
 ** power cores

Data cable PROFIBUS DP

acc. to VG 95218 part 31F

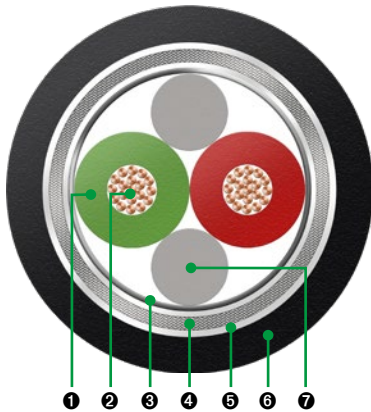

Data cable CAN-Bus

acc. to VG 95218 part 31H

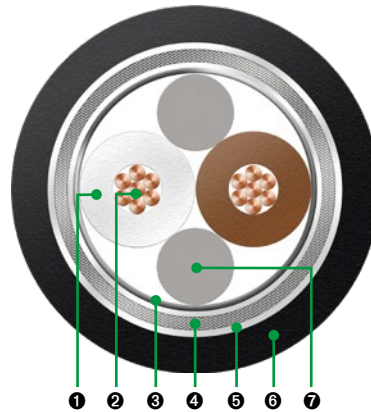

Application & characteristics

Suitable for fixed installation inside military vessels.
 Suitable for fixed installation in harsh environment areas.
 Operating temperature > -33 °C up to +85 °C

Construction

- ① Core > conductor with fine stranded wires
- ② Insulation > special elastomer, RD, GN
- ③ Tape > plastic foil
- ④ Outer shielding > copper braid with tin-plated wires
- ⑤ Tape > plastic foil
- ⑥ Sheath > flame retardant, cross-linked, black
- ⑦ Filler

Application & characteristics

Suitable for fixed installation inside military vessels.
 Suitable for fixed installation in harsh environment areas.
 Operating temperature > -33 °C up to +85 °C

Construction

- ① Core > conductor with fine stranded wires
- ② Insulation > special elastomer, WH, BN
- ③ Tape > plastic foil
- ④ Outer shielding > copper braid with tin-plated wires
- ⑤ Tape > plastic foil
- ⑥ Sheath > flame retardant, cross-linked, black
- ⑦ Filler

Type description	Ø single core max.	Sheath wall thickness min.	Cable Ø min.	Cable Ø max.	Weight max.	Transfer impedance max.	Operating voltage AC/DC	VG part no.	Order no.
	mm	mm	mm	mm	kg/km	mΩ/m	V		
acc. to VG 95218 part 31F									
PROFIBUS 2x0.35	3.1	1.3	9.6	10.0	110	15	125	VG 95218 T031F001	ERK 017460
PROFIBUS 2x0.35	2.8	1.3	9.0	9.4	110	20	125	VG 95218 T031F002	ERK 20657
acc. to VG 95218 part 31H									
CAN-Bus 2 x 0.34	2.18	1.3	7.6	8.0	90	15	125	VG 95218 T031H001	ERK 017461
CAN-Bus 2 x 0.34	2.15	1.3	7.6	8.0	90	15	125	VG 95218 T031H002	ERK 020658
CAN-Bus 2 x 0.5	2.35	1.08	7.6	8.2	83	25	125	VG 95218 T031H003	ERK 020659

Thermo-compensaiting cable

acc. to VG 95218-7 type D

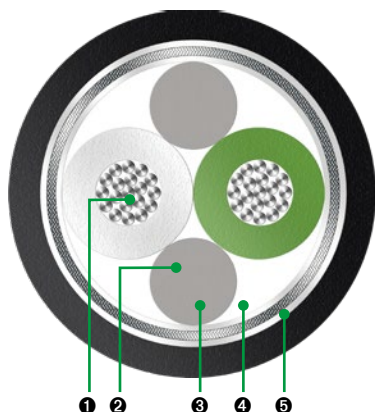

Application & characteristics

Suitable for fixed installation inside military vessels. Suitable for fixed installation in harsh environment areas.
Operating temperature (Type D) > $-40\text{ }^{\circ}\text{C}$ up to $+90\text{ }^{\circ}\text{C}$

Construction

- ① Core > conductor with stranded wires NiCr-Ni
- ② Filler
- ③ Wrapping
- ④ Screening braid
- ⑤ Sheat > flame retardant, cross-linked, black

Fire performance

Flame retardancy	IEC 60332-1-2 and IEC 60332-3-22 Cat. C
Smoke density	IEC 61034
Absence of halogen	IEC 60754-1
Acidity of combustion gases	IEC 60754-2

Type description	Ø single core max.	Sheath wall thickness min.	Cable Ø min.	Cable Ø max.	Weight max.	Transfer impedance max.	Operating voltage AC/DC	VG part no.	Order no.
	mm	mm	mm	mm	kg/km	mΩ/m	V		
acc. to VG 95218 part 31D									
2 x 0.34	0.8	0.8	4.9	5.3	42	30	450	VG95218T007D001	ERK 025343
2 x 0.5	1.0	0.9	5.5	5.9	52	30	450	VG95218T007D002	ERK 025344
2 x 0.75	1.2	1.0	5.9	6.3	62	30	450	VG95218T007D003	ERK 025345
2 x 1.0	1.4	1.0	6.6	7.0	77	30	450	VG95218T007D004	ERK 025346
2 x 1.5	1.7	1.1	7.2	7.6	93	30	450	VG95218T007D005	ERK 025347

Installation wire hook-up

acc. to VG 95218 part 20P

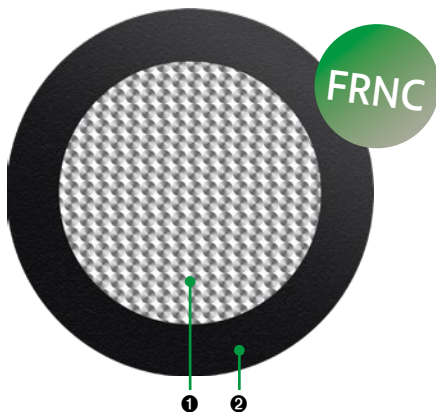

Application & characteristics

The wiring lines distinguish by their halogen free features and an improved behavior in case of fire. In this case the generating of corrosive and toxic fission products is down to a minimum and the light transparency is at least 75 %.

Operating temperature > $-55\text{ }^{\circ}\text{C}$ up to $+105\text{ }^{\circ}\text{C}$

Max. voltage > AC 600 V / DC 900 V

Construction

- ❶ Core > conductor with fine stranded wires
- ❷ Insulation > the insulation material has a high resistance against many types of oil, grease, lubricants and other chemical materials.

Installation wire, hook-up

Type description		Colors Part No. acc. to VG95218T020 BizLink part No.										
nom. mm ²	AWG	black 0	brown 1	red 2	orange 3	yellow 4	green 5	blue 6	violet 7	grey 8	white 9	yellow/green G
0.15	26	P120	P121	P122	P123	P124	P125	P126	P127	P128	P129	P12G
		ESL 016090	ESL 016091	ESL 016092	ESL 016093	ESL 016094	ESL 016095	ESL 016096	ESL 016097	ESL 016098	ESL 016089	ESL 016099
0.25	24	P010	P011	P012	P013	P014	P015	P016	P017	P018	P019	P01G
		ESL 016126	ESL 016127	ESL 016128	ESL 016129	ESL 016130	ESL 016131	ESL 016132	ESL 016133	ESL 016134	ESL 016025	ESL 016135
0.4	22	P020	P021	P022	P023	P024	P025	P026	P027	P028	P029	P02G
		ESL 016138	ESL 016139	ESL 016140	ESL 016141	ESL 016142	ESL 106143	ESL 016144	ESL 016145	ESL 016146	ESL 016137	ESL 016147
0.5	21	P030	P031	P032	P033	P034	P035	P036	P037	P038	P039	P03G
		ESL 016198	ESL 016199	ESL 016200	ESL 016201	ESL 016202	ESL 016203	ESL 016204	ESL 016205	ESL 016206	ESL 016197	ESL 016207
0.6	20	P040	P041	P042	P043	P044	P045	P046	P047	P048	P049	P04G
		ESL 016114	ESL 106115	ESL 016116	ESL 016117	ESL 016118	ESL 016119	ESL 016120	ESL 016121	ESL 016122	ESL 016113	ESL 016123
0.75	19	P050	P051	P052	P053	P054	P055	P056	P057	P058	P059	P05G
		ESL 016102	ESL 016103	ESL 016104	ESL 016105	ESL 016106	ESL 016107	ESL 016108	ESL 016109	ESL 016110	ESL 016101	ESL 016111
1.0	18	P060	P061	P062	P063	P064	P065	P066	P067	P068	P069	P06G
		ESL 016209	ESL 016210	ESL 016211	ESL 016212	ESL 016213	ESL 016214	ESL 016215	ESL 016216	ESL 016217	ESL 016208	ESL 016218
1.2	16	P070	P071	P072	P073	P074	P075	P076	P077	P078	P079	P07G
		ESL 016150	ESL 016151	ESL 016152	ESL 016153	ESL 016154	ESL 016155	ESL 016156	ESL 016157	ESL 016158	ESL 016149	ESL 016159
1.5	15	P080	P081	P082	P083	P084	P085	P086	P087	P088	P089	P08G
		ESL 016220	ESL 016221	ESL 016222	ESL 016223	ESL 016224	ESL 016225	ESL 016226	ESL 016227	ESL 016228	ESL 016219	ESL 016229
2.0	14	P090	P091	P092	P093	P094	P095	P096	P097	P098	P099	P09G
		ESL 016162	ESL 016163	ESL 016164	ESL 016165	ESL 016166	ESL 016167	ESL 016168	ESL 016169	ESL 016170	ESL 016161	ESL 016171
2.5	13	P100	P101	P102	P103	P104	P105	P106	P107	P108	P109	P10G
		ESL 016174	ESL 016175	ESL 016176	ESL 016177	ESL 016178	ESL 016179	ESL 016180	ESL 016181	ESL 016182	ESL 016173	ESL 016183
3.0	12	P110	P111	P112	P113	P114	P115	P116	P117	P118	P119	P11G
		ESL 016186	ESL 016187	ESL 016188	ESL 016189	ESL 016190	ESL 016191	ESL 016192	ESL 016193	ESL 016194	ESL 016185	ESL 016195
4.0	12	P130	P131	P132	P133	P134	P135	P136	P137	P138	P139	P13G
		ESL 024074	ESL 024075	ESL 024076	ESL 024077	ESL 024078	ESL 024079	ESL 024080	ESL 024081	ESL 024082	ESL 024083	ESL 024084
6.0	10	P140	P141	P142	P143	P144	P145	P146	P147	P148	P149	P14G
		ESL 024085	ESL 024086	ESL 024087	ESL 024088	ESL 024089	ESL 024090	ESL 024091	ESL 024092	ESL 024093	ESL 024094	ESL 024095
10	8	P150	P151	P152	P153	P154	P155	P156	P157	P158	P159	P15G
		ESL 024097	ESL 024098	ESL 024099	ESL 024100	ESL 024101	ESL 024102	ESL 024103	ESL 024104	ESL 024105	ESL 024106	ESL 024107
16	6	P160	P161	P162	P163	P164	P165	P166	P167	P168	P169	P16G
		ESL 025172	ESL 025173	ESL 025174	ESL 025175	ESL 025176	ESL 025177	ESL 025178	ESL 025179	ESL 025180	ESL 025181	ESL 025183
25	4	P170	P171	P172	P173	P174	P175	P176	P177	P178	P179	P17G
		*	*	*	*	*	*	*	*	*	ESL 026483	*
35	2	P180	P181	P182	P183	P184	P185	P186	P187	P188	P189	P18G
		*	*	*	*	*	*	*	*	*	ESL 026484	*
50		P190	P191	P192	P193	P194	P195	P196	P197	P198	P199	P19G
		*	*	*	*	*	*	*	*	*	ESL 028682	*
70		P200	P201	P202	P203	P204	P205	P206	P207	P208	P209	P20G
		ESL 028685	*	*	*	*	*	*	*	*	*	*
95		P210	P211	P212	P213	P214	P215	P216	P217	P218	P219	P21G
		ESL 028684	*	*	*	*	*	*	*	*	ESL 028683	*
120		P220	P221	P222	P223	P224	P225	P226	P226	P228	P229	P22G
		ESL 028717	*	*	*	*	*	*	*	*	*	*
150		P230	P231	P232	P233	P234	P235	P236	P237	P238	P239	P23G
		*	*	*	*	*	*	*	*	*	*	*

* on request

Open twisted installation wire

acc. to V95218-21 part 21F

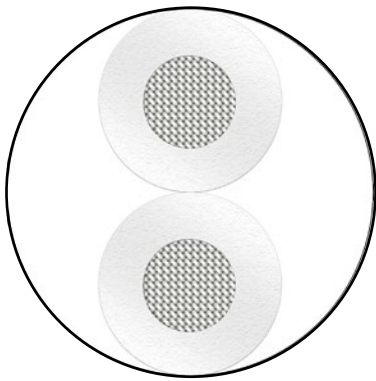

Application & characteristics

The wiring lines distinguish by their halogen free features and an improved behavior in case of fire. In this case the generating of corrosive and toxic fission products is down to a minimum and the light transparency is at least 75 %.

Operating temperature > -55 °C up to +105 °C

Max. voltage > AC 600 V / DC 900 V

Construction

- ❶ Core > conductor with fine stranded wires
- ❷ Insulation > the insulation material has a high resistance against many types of oil, grease, lubricants and other chemical materials. 3 open twisted element

Lightweight power cables with overall electrical screen LMGSGO acc. to VG 95218 part 28C

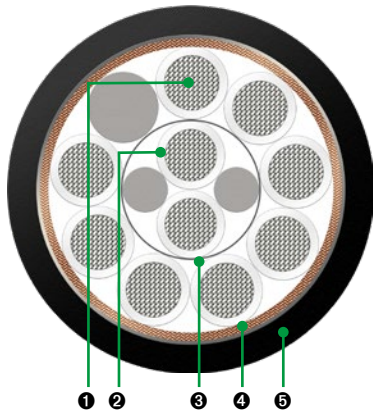

Application & characteristics

Suitable for fixed installation inside military vessels. Suitable for fixed installation in harsh environment areas.

Suitable for fixed installation in military vehicles. Operating temperature > -40 °C up to +105 °C

Construction

- ① Core > conductor with fine stranded wires
- ② Insulation > special elastomer
- ③ Wires acc. to VG 95218 part 28P
- ④ Outer shielding > copper braid with tin-plated wires
- ⑤ Sheath > flame retardant, cross-linked, black

Type description	Ø single core max.	Sheath wall thickness min.	Cable Ø min.	Cable Ø max.	Weight max.	Transfer impedance max.	Operating voltage AC/DC	VG part no.	Order no.
	mm	mm	mm	mm	kg/km	mΩ/m	V		
acc. to VG 95218 part 28C									
LMGSGO 2x1.5	2.34	0.7	6.2	7.0	94	100	600/900	VG95218T028C083	ERK 016866
LMGSGO 3x1.5	2.34	0.7	6.5	7.3	105	100	600/900	VG95218T028C122	ERK 016867
LMGSGO 4x1.5	2.34	0.7	7.1	7.9	135	100	600/900	VG95218T028C088	ERK 016885
LMGSGO 5x1.5	2.34	0.7	7.6	8.4	156	100	600/900	VG95218T028C090	ERK 016887
LMGSGO 7x1.5	2.34	0.7	8.2	9.0	196	70	600/900	VG95218T028C046	ERK 016894
LMGSGO 10x1.5	2.34	0.8	10.5	11.7	275	45	600/900	VG95218T028C052	ERK 016478
LMGSGO 12x1.5	2.34	0.8	10.8	12.8	309	45	600/900	VG95218T028C055	ERK 016847
LMGSGO 14x1.5	2.34	0.8	11.3	12.5	358	45	600/900	VG95218T028C058	ERK 016903
LMGSGO 16x1.5	2.34	0.8	11.9	13.1	402	45	600/900	VG95218T028C060	ERK 016906
LMGSGO 19x1.5	2.34	0.8	12.5	13.7	456	45	600/900	VG95218T028C061	ERK 016908
LMGSGO 24x1.5	2.34	0.7	15.3	16.1	585	30	600/900	VG95218T028C065	ERK 016917
LMGSGO 27x1.5	2.34	0.8	15.0	16.6	640	30	600/900	VG95218T028C066	ERK 016919
LMGSGO 33x1.5	2.34	0.9	15.8	17.6	760	30	600/900	VG95218T028C070	ERK 016926
LMGSGO 37x1.5	2.34	1.0	18.2	19.2	868	30	600/900	VG95218T028C005	ERK 016928
LMGSGO 2x2.5	2.79	0.7	7.1	7.9	126	100	600/900	VG95218T028C084	ERK 016865
LMGSGO 3x2.5	2.79	0.7	7.5	8.3	151	100	600/900	VG95218T028C086	ERK 016864
LMGSGO 4x2.5	2.79	0.7	8.2	9.0	186	70	600/900	VG95218T028C089	ERK 016862
LMGSGO 7x2.5	2.79	0.7	9.6	10.8	278	45	600/900	VG95218T028C048	ERK 016896
LMGSGO 3G1.5	2.34	0.7	6.5	7.3	105	100	600/900	VG95218T028C085	ERK 016879
LMGSGO 5G1.5	2.34	0.7	7.6	8.4	156	100	600/900	VG95218T028C091	ERK 016888
LMGSGO 7G1.5	2.34	0.7	8.0	8.8	196	70	600/900	VG95218T028C047	ERK 016895
LMGSGO 10G1.5	2.34	0.8	10.5	11.5	281	45	600/900	VG95218T028C053	ERK 016845
LMGSGO 3G2.5	2.79	0.7	7.5	8.3	151	100	600/900	VG95218T028C087	ERK 016881
LMGSGO 5G2.5	2.79	0.8	9.3	10.1	230	100	600/900	VG95218T028C128	ERK 028493
LMGSGO 7G2.5	2.79	0.7	9.6	10.8	278	45	600/900	VG95218T028C129	ERK 028494

Communication cables with overall electrical screen FMGSGO

acc. to VG 95218 part 28C

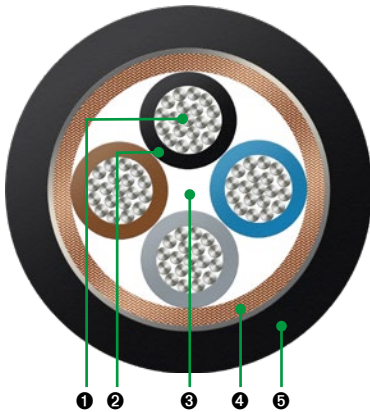

Application & characteristics

Suitable for fixed installation inside military vessels. Suitable for fixed installation in harsh environment areas.
 Suitable for fixed installation in military vehicles. Operating temperature > -40 °C up to +105 °C

Construction

- ❶ Core > conductor with fine stranded wires
- ❷ Insulation > special elastomer
- ❸ Twisted elements acc. to VG 95218 part 21F
- ❹ Outer shielding > copper braid with tin-plated wires
- ❺ Sheath > flame retardant, cross-linked, black

Type description	Ø single core max. mm	Sheath wall thickness min. mm	Cable Ø min. mm	Cable Ø max. mm	Weight max. kg/km	Transfer impedance max. mΩ/m	Operating voltage AC/DC V	VG part no.	Order no.
acc. to VG 95218 part 28C									
FMGSGO 1x2x0.75	1.77	0.7	5.2	5.6	57	100	600/900	VG95218T028C082	ERK 016945
FMGSGO 2x2x0.75	1.77	0.7	5.7	6.3	79	100	600/900	VG95218T028C040	ERK 016472
FMGSGO 4x2x0.75	1.77	0.7	8.7	9.7	162	70	600/900	VG95218T028C050	ERK 016898
FMGSGO 6x2x0.75	1.77	0.8	10.1	11.3	225	45	600/900	VG95218T028C054	ERK 016846
FMGSGO 8x2x0.75	1.77	0.8	11.0	12.0	269	45	600/900	VG95218T028C059	ERK 016904
FMGSGO 10x2x0.75	1.77	0.8	12.2	13.4	341	30	600/900	VG95218T028C062	ERK 016911
FMGSGO 14x2x0.75	1.77	0.8	13.0	14.4	402	45	600/900	VG95218T028C067	ERK 016921
FMGSGO 16x2x0.75	1.77	0.8	14.4	15.8	479	30	600/900	VG95218T028C069	ERK 016924

Lightweight power cables

with overall electrical screen LFMGSSGO
acc. to VG 95218 part 28E

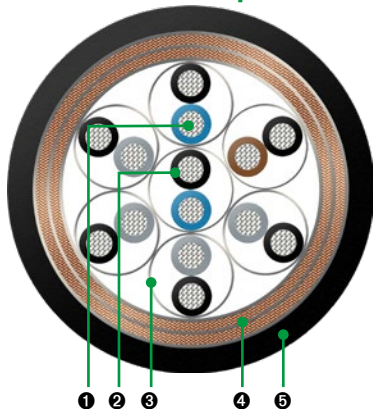

Lightweight communication cables

with overall electrical screen LFMGSGO
acc. VG 95218 part 28C

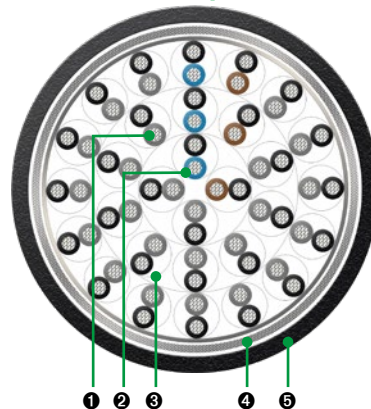

Application & characteristics

Suitable for fixed installation inside military vessels.
Suitable for fixed installation in harsh environment areas.
Suitable for fixed installation in military vehicles.
Operating temperature > -40 °C up to +105 °C

Construction

- ① Core > conductor with fine stranded wires
- ② Insulation > special elastomer
- ③ Twisted pairs acc. to VG 95218 part 21F
- ④ Double outer shielding > copper braid with tin-plated wires
- ⑤ Sheath > flame retardant, cross-linked, black

Application & characteristics

Suitable for fixed installation inside military vessels.
Suitable for fixed installation in harsh environment areas.
Suitable for fixed installation in military vehicles.
Operating temperature > -40 °C up to +105 °C

Construction

- ① Core > conductor with fine stranded wires
- ② Insulation > special elastomer
- ③ Twisted pairs acc. to VG 95218 part 21F
- ④ Outer shielding > copper braid with tin-plated wires
- ⑤ Sheath > flame retardant, cross-linked, black

Type description	Ø single core max.	Sheath wall thickness min.	Cable Ø min.	Cable Ø max.	Weight max.	Transfer impedance max.	Operating voltage AC/DC	VG part no.	Order no.
	mm	mm	mm	mm	kg/km	mΩ/m	V		
power cables – LMGSGO									
LFMGSSGO 2x2x0.4	1.46	0.7	5.8	6.4	78	10	600/900	VG95218T028E004	ERK 019203
LFMGSSGO 4x2x0.4	1.46	0.7	8.0	9.0	139	10	600/900	VG95218T028E005	ERK 019196
LFMGSSGO 7x2x0.4	1.46	0.7	9.5	10.5	184	5	600/900	VG95218T028E006	ERK 016480
LFMGSSGO 12x2x0.4	1.46	0.8	11.5	12.7	285	5	600/900	VG95218T028E008	ERK 019202
LFMGSSGO 19x2x0.4	1.46	0.8	13.6	15.0	396	5	600/900	VG95218T028E010	ERK 017348
LFMGSSGO 27x2x0.4	1.46	0.9	16.1	17.9	569	5	600/900	VG95218T028E011	ERK 017362

communication cables – LFMGSGO									
LFMGSGO 30x2x0.4	1.46	0.9	15.5	17.1	493	30	600/900	VG95218T028C076	ERK 016937
LFMGSGO 45x2x0.4	1.46	0.9	18.1	20.0	699	30	600/900	VG95218T028C077	ERK 016940
LFMGSGO 60x2x0.15	1.13	1.7	19.5	21.5	643	50	600/900	VG95218T028C030	ERK 016944
LFMGSGO 1 x 2 x 0,5	0.94	0.7	5.1	5.5	49	100	600/900	VG95218T028C132	ERK 029026
LFMGSGO 2 x 2 x 0.5	0.94	0.7	7.9	8.3	92	70	600/900	VG95218T028C133	ERK 029027
LFMGSGO 3 x 2 x 0.4	0.84	0.7	8.0	8.4	101	70	600/900	VG95218T028C134	ERK 029028
LFMGSGO 4 x 2 x 0.5	0.94	0.9	11.3	11.7	193	50	600/900	VG95218T028C130	ERK 028991
LFMGSGO 4 x 2 x 0.25	0.66	0.7	6.6	7.2	96	100	600/900	VG95218T028C135	ERK 029119
LFMGSGO 10 x 2 x 0.5	0.94	1.1	16.8	17.6	420	100	600/900	VG95218T028C131	ERK 028996

Lightweight communication cables

with pair and overall electrical screen
LFMSGSGO acc. to VG 95218 part 28C

with pair and twin-overall electrical screen
LFMSGSSGO acc. to VG 95218 part 28E

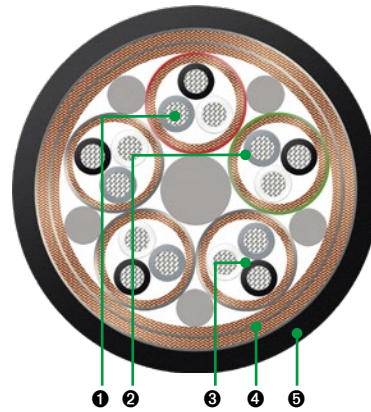
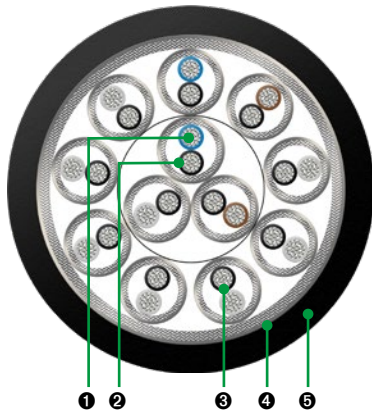

Application & characteristics

Suitable for fixed installation inside military vessels.
 Suitable for fixed installation in harsh environment areas.
 Suitable for fixed installation in military vehicles.
 Operating temperature > -40 °C up to +105 °C

Application & characteristics

Suitable for fixed installation inside military vessels.
 Suitable for fixed installation in harsh environment areas.
 Suitable for fixed installation in military vehicles.
 Operating temperature > -40 °C up to +105 °C

Construction

- ❶ Core > conductor with fine stranded wires
- ❷ Insulation > special elastomer
- ❸ Twisted pairs acc. to VG 95218 part 21F
- ❹ Outer shielding > copper braid with tin-plated wires
- ❺ Sheath > flame retardant, cross-linked, black

Construction

- ❶ Core > conductor with fine stranded wires
- ❷ Insulation > special elastomer
- ❸ Twisted triples acc. to VG 95218 part 21F
- ❹ Double outer shielding > copper braid with tin-plated wires
- ❺ Sheath > flame retardant, cross-linked, black

Type description	Ø single core max.	Sheath wall thickness min.	Cable Ø min.	Cable Ø max.	Weight max.	Transfer impedance max.	Operating voltage AC/DC	VG part no.	Order no.
	mm	mm	mm	mm	kg/km	mΩ/m	V		
communication cables – LFMSGSGO									
LFMSGSGO 2x2x0.4	1.46	0.7	8.3	9.1	125	70	600/900	VG95218T028C039	ERK 016882
LFMSGSGO 4x2x0.4	1.46	0.7	9.3	10.3	178	45	600/900	VG95218T028C049	ERK 016897
LFMSGSGO 7x2x0.4	1.46	0.8	11.3	12.3	263	45	600/900	VG95218T028C056	ERK 016851
LFMSGSGO 12x2x0.4	1.46	0.8	13.7	15.1	407	30	600/900	VG95218T028C064	ERK 016916
LFMSGSGO 19x2x0.4	1.46	0.8	16.8	18.6	603	30	600/900	VG95218T028C071	ERK 016931
LFMSGSGO 27x2x0.4	1.46	0.9	19.4	21.4	806	30	600/900	VG95218T028C075	ERK 016935

communication cables – LFMSGSSGO									
LFMSGSSGO 5x3x0.4	1.46	0.8	11.6	12.8	328	5	600/900	VG95218T028E007	ERK 016733
LFMSGSSGO 12x3x0.4	1.46	0.9	16.5	18.3	624	5	600/900	VG95218T028E009	ERK 016868

Cross reference list for NavaLine®

acc. to VG 95218 part 28 and 61-66



No. of cores x nom. cross section mm ²	Dash-No. VG 95218 part 28	Dash-No. VG 95218 part 61-66	Order no.
--	---------------------------------	------------------------------------	-----------

LMGSGO	T28	T61	
2x1.5	C083	A019	ERK 016866
3x1.5	C122	A021	ERK 016867
4x1.5	C088	A025	ERK 016885
5x1.5	C090	A027	ERK 016887
7x1.5	C046	A116	ERK 016894
10x1.5	C052	A120	ERK 016478
12x1.5	C055	A122	ERK 016847
14x1.5	C058	A123	ERK 016903
16x1.5	C060	A124	ERK 016906
19x1.5	C061	A125	ERK 016908
24x1.5	C065	A126	ERK 016917
27x1.5	C066	A127	ERK 016919
33x1.5	C070	A128	ERK 016926
37x1.5	C005	A129	ERK 016928
2x2.5	C084	A020	ERK 016865
3x2.5	C086	A023	ERK 016864
4x2.5	C089	A026	ERK 016862
7x2.5	C048	A118	ERK 016896
3G1.5	C085	A022	ERK 016879
5G1.5	C091	A028	ERK 016888
7G1.5	C047	A117	ERK 016895
10G1.5	C053	A121	ERK 016845
3G2.5	C087	A115	ERK 016881
5G2.5	C128	A107	ERK 028493
7G2.5	C129	A119	ERK 028494

FMGSGO	T28	T62	
1x2x0.75	C082	A008	ERK 016945
2x2x0.75	C040	A001	ERK 016472
4x2x0.75	C050	A002	ERK 016898
6x2x0.75	C054	A003	ERK 016846

No. of cores x nom. cross section mm ²	Dash-No. VG 95218 part 28	Dash-No. VG 95218 part 61-66	Order no.
--	---------------------------------	------------------------------------	-----------

8x2x0.75	C059	A004	ERK 016904
10x2x0.75	C062	A005	ERK 016911
14x2x0.75	C067	A006	ERK 016921
16x2x0.75	C069	A007	ERK 016924

FMGSGGO	T28	T63	
2x2x0.75	C041	A001	ERK 016884
4x2x0.75	C051	A002	ERK 016550
7x2x0.75	C057	A003	ERK 026836
11x2x0.75	C063	A004	ERK 016899
14x2x0.75	C068	A005	ERK 016922
19x2x0.75	C072	A006	ERK 016932
24x2x0.75	C074	A007	ERK 016933

LFMGSSGO	T28	T64	
2x2x0.4	E004	A001	ERK 019203
4x2x0.4	E005	A002	ERK 019196
7x2x0.4	E006	A003	ERK 016480
12x2x0.4	E008	A004	ERK 019202
19x2x0.4	E010	A005	ERK 017348
27x2x0.4	E011	A006	ERK 017362

LFMSGSGO	T28	T65	
2x2x0.4	C039	A001	ERK 016882
4x2x0.4	C049	A002	ERK 016897
7x2x0.4	C056	A003	ERK 016851
12x2x0.4	C064	A004	ERK 016916
19x2x0.4	C071	A005	ERK 016931
27x2x0.4	C075	A006	ERK 016935

LFMSGSSGO	T28	T66	
5x3x0.4	E007	A001	ERK 016733
12x3x0.4	E009	A002	ERK 016868

Coaxial cable

acc. to VG 95218 part 101

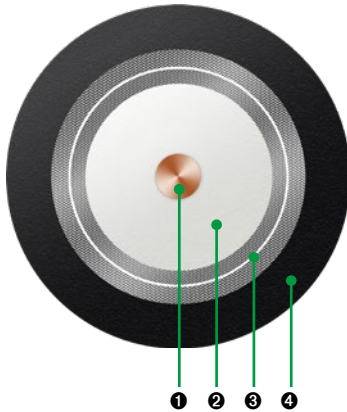

Application & characteristics

Suitable for fixed installation

- inside military vessels
- in harsh environment areas
- in military vehicles

Operating temperature > -40 °C up to +105 °C

Construction

- 1 Central core
- 2 Dielectrical insulation
- 3 Shielding > copper braid with tin-plated wires
- 4 Sheath > flame retardant, cross-linked, black

Type description	Ø central core mm	Sheath wall thickness min. mm	Cable Ø min. mm	Cable Ø max. mm	Characteristic impedance max. Ω	Weight max. kg/km	VG part no.	Order no.
acc. to VG 95218 part 101								
RG 11	1,2	1,1	10,1	10,5	75 ± 3	180	VG95218T101F001	ECX 029158
RG 58	0,9	0,7	4,8	5,1	50 ± 2	50	VG95218T101B001	ECX 029116
RG 59	0,6	0,8	6,0	6,3	75 ± 2	80	VG95218T101D001	ECX 029044
RG 213	2,25	1,1	10,1	10,5	50 ± 2	175	VG95218T101A002	ECX 029160
RG 214	2,25	1,0	10,6	11,0	50 ± 2	220	VG95218T101C002	ECX 029115
RG 216	1,2	1,0	10,6	11,0	75 ± 3	210	VG95218T101E001	ECX 029137
RG 223	0,9	0,6	5,25	5,55	50 ± 2	66	VG95218T101C001	ECX 029133

Individually designed NavaLine® installation cable

acc. to VG 95218-8 / acc. to VG 95218-9

Without any relation to VG standards BizLink is able to design and produce outboard and inboard cables with following elements:

- Single wires up to a voltage of 1.5 kV AC
- Twisted pairs up to a voltage of 1.0 kV AC
- Ethernet data (LAN) elements up to Cat 7

- Bus elements
- Fiber optic elements
- Coaxial elements
- Electrical screens
- Water-blocking tapes and fillers
(up to a pressure of 100 bars for the complete cable)

The standard VG 95218-8 describes different types of sheathing material which can be used for individually designed VG cables >

For the design of the individually designed cables are allowed to use the following elements to cover the cable by the standard VG 95218-9 (all elements available from BizLink) >

Installation cable acc. to VG 95218-8				
Place of cable installation	Material type	Acc. to standard	Main characteristics	Type of sheath acc. to VG 95218-8
All military applications, but not under water	Cross-linked	VG 95218-28, type C and E	Halogen-free Non-toxic Non corrosive Flame retardant	B
Inboard vessels	Cross-linked	VG 95218-29 type B to F		E
		VG 95218-31 type D, F and H		D
Outboard vessels	Cross-linked	VG 95218-29 type B to F	E	
	Polyurethane	VG 95218-29 type G to M	Halogen-free Flame retardant	F
All military applications, but not under water	Cross-linked	VG 95218-30 type A and B	Halogen-free Non-toxic Non corrosive Flame retardant	G
Fixed and portable installation	Cross-linked	VG 95218-31 type L		H

Installation cable acc. to VG 95218-9		
Type of sheath acc. to VG 95218-8	Approved constructions elements	Type of element
B	VG95218T020P...	Single core
	VG95218T021F...	Twisted pair
	VG95218T022G...	Single core with screen and protective cover
	VG95218T023C...	Cables with screen and protective cover
	VG95218T023G...	Cables with screen and protective cover
	VG95218T030B...*	Fiber optic cables, bundle design
	VG95218T031D...*	Ethernet Cat. 7
D	VG95218T031F...*	Profibus DP
	VG95218T031H...*	CAN-Bus
	VG95218T101*	Coaxial cables
	VG95218T020P...	Single core
	VG95218T021F...	Twisted pair
	VG95218T022G...	Single core with screen and protective cover
	VG95218T023C...	Cables with screen and protective cover
E	VG95218T023G...	Cables with screen and protective cover
	VG95218T030B...*	Fiber optic cables, bundle design
	VG95218T031D...*	Ethernet Cat. 7
	VG95218T031F...*	Profibus DP
	VG95218T031H...*	CAN-Bus
	VG95218T101*	Coaxial cables
	F	VG95218T020L...
VG95218T020M...		Single core water-blocked
G	VG 95218T030A...	Fiber optic cables, breakout design
	VG95218T030B...	Fiber optic cables, bundle design
H	VG95218T030H...	CAN-Bus

* with or without outer sheath

Individually designed **NavalLine®** installation cable without any relation to VG standards

Customized **NavalLine®** solutions according to your requests

BizLink is able to design and produce outboard and inboard cables with following elements:

- Single wires up to a voltage of 1.5 kV AC
- Twisted pairs up to a voltage of 1.0 kV AC
- Ethernet data (LAN) elements up to Cat 7
- Bus elements
- Fiber optic elements
- Hoses for fluids and gases
- Coaxial elements
- Electrical screens
- Magnetic screens
- Strengths members
- Armor
- Sheath with different characteristics in single or double-layer design
- Water-blocking tapes and fillers (up to a pressure of 100 bars for the complete cable)

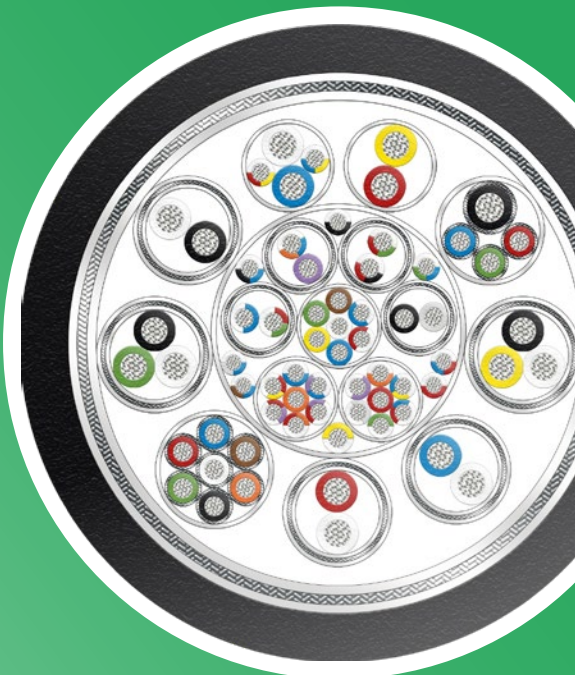

About BizLink Group



BizLink

Find out more > www.bizlinktech.com

BizLink, founded in 1996, is headquartered in Silicon Valley, USA. Our mission is to make interconnection easier and to become the leading global interconnect solution supplier.

We support industries that are environmentally conscious and improve quality of life through providing essential components, wire harnesses, and cables to a wide variety of industries such as IT Infrastructure, Client Peripherals, Optical Fiber Communications, Telecom and Networking, Electrical Appliances, Healthcare, Factory Automation, Machinery and Sensors, Motor Vehicle, Rolling Stock, Marine, Industrial, and Solar.

In addition, with flexible production resources and global R&D teams in America, Europe, and Asia, BizLink always provides reliable interconnect solutions in close proximity to markets. BizLink also specializes in providing one-stop EMS and NPI services based on customer's requests.

At BizLink, we strive to keep collaborating closely with customers to turn their innovative ideas into reality.

Sales network Marine – worldwide

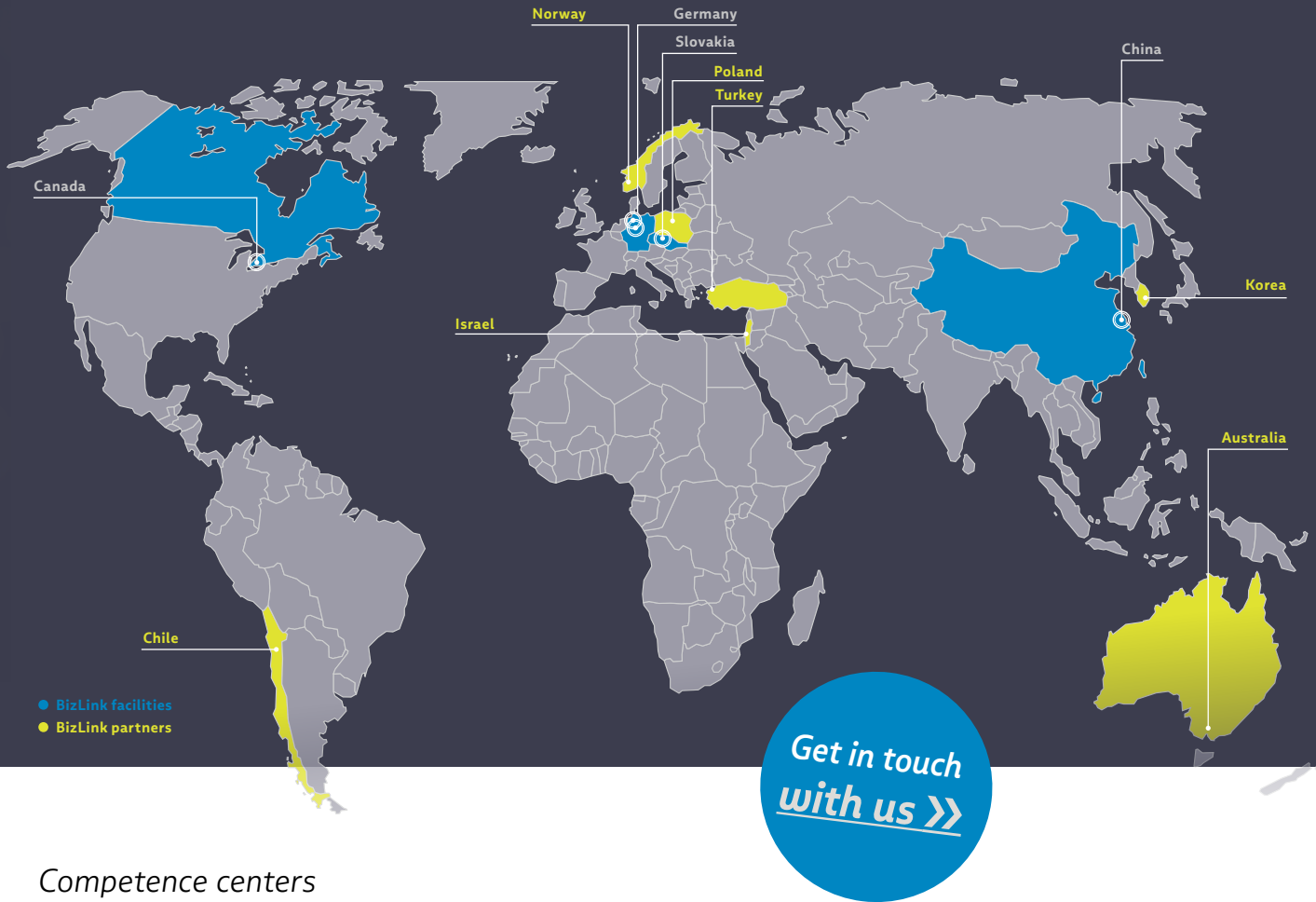

Competence centers

Germany

BizLink elocab GmbH

Obere Lerch 34
91166 Georgensmuend, Germany
T +49 9172 6980-0

BizLink Special Cables Germany GmbH

Eschstrasse 1
26169 Friesoythe, Germany
T +49 4491 291-5010

Slovakia

BizLink Industry Slovakia Spol. s.r.o.

Canada

BizLink elocab Ltd.

China

BizLink Special Cables (Changzhou)
Co., Ltd.

BizLink partner

- Turkey
- Korea
- Norway
- Australia
- Israel
- Chile
- Poland



Our Sales Network worldwide >

Marine

BizLink elocab GmbH

Obere Lerch 34 · 91166 Georgensgmünd
Germany



marine.bizlinktech.com

marine_info@bizlinktech.com

[!\[\]\(fa6f3af6bfa46c5d4a2d362681095beb_img.jpg\) Follow us on LinkedIn](#)

© 2022 BizLink Group. All rights reserved. September 2022
BizLink and other trademarks are trademarks of BizLink Group or its
subsidiaries. Other trademarks may be trademarks of their respective
owners.
Specifications are subject to change without prior notice.